

APPEL INFIRMIERE GETS, INTEGRABLE DANS LE FORMAT 45

DIGICONTACT Série L

19 04 2006

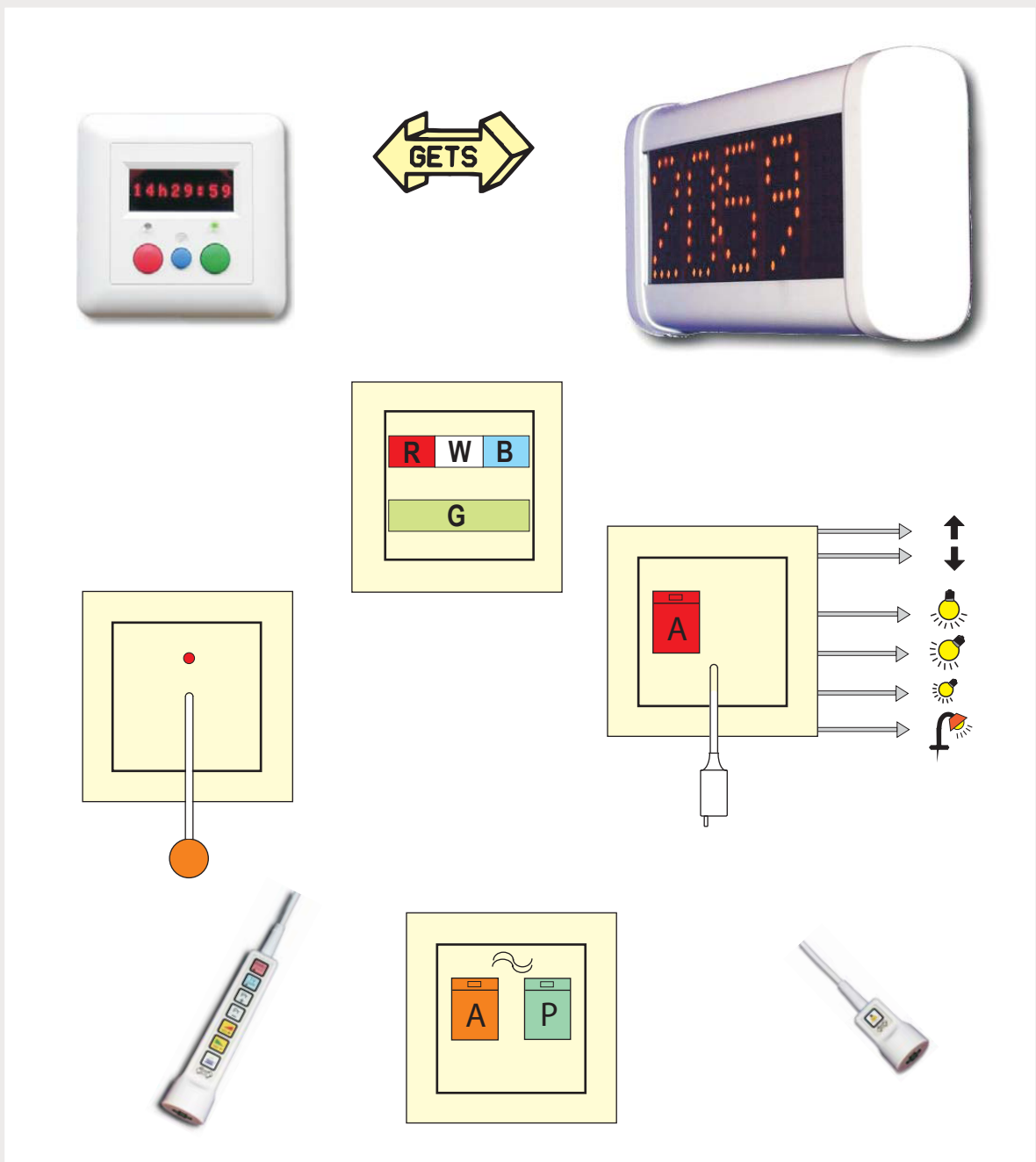

APPEL INFIRMIERE GETS, INTEGRABLE DANS LE FORMAT 45

Tirette, poussoirs et prises éjectables, pour série L, M ou P

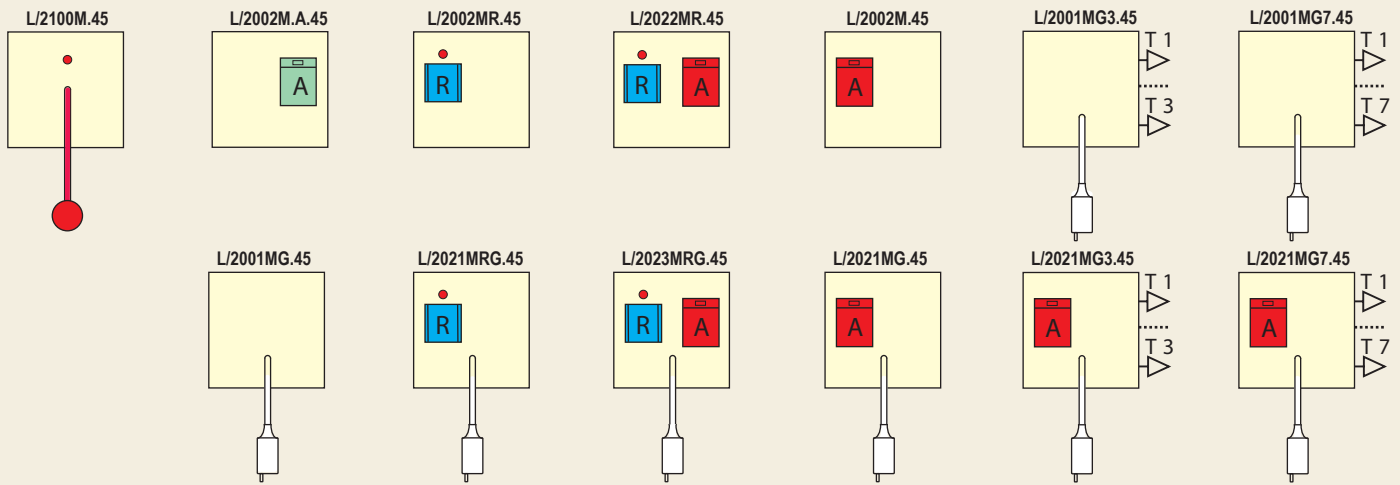

Bloc portes acquit/présence, pour hublot L ou M

Hublot plexy
(pasif)

L/2202P.RG.45

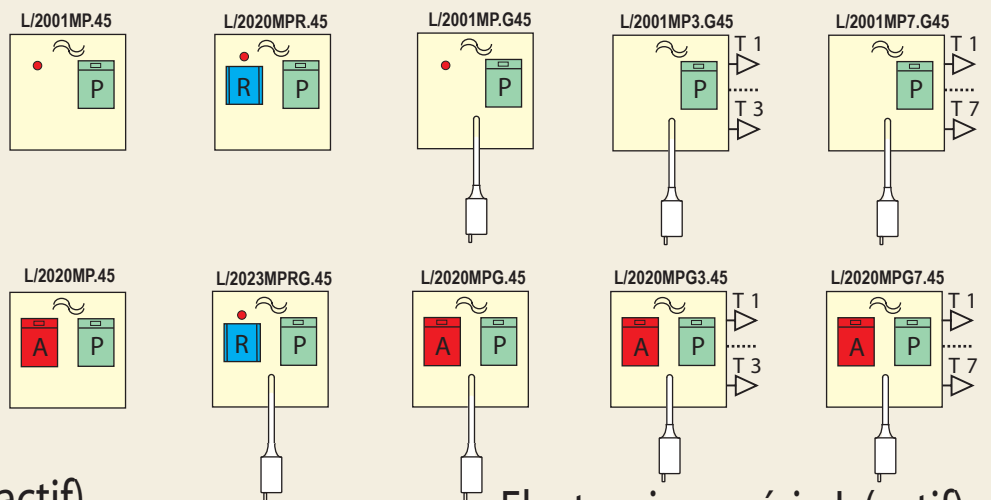
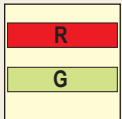

Hublot plexy série L (actif)

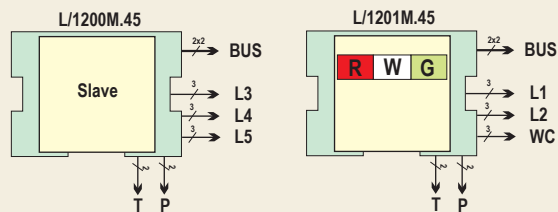

Electronique série L (actif)

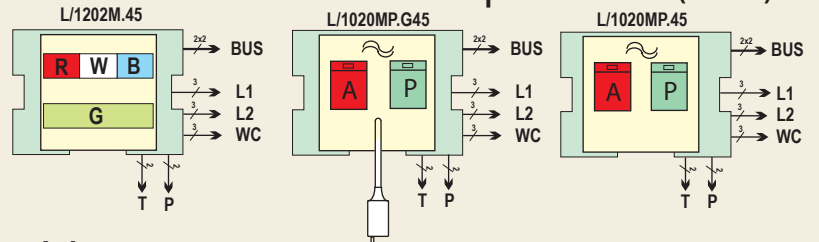

Poires d'appel éjectables à ouverture. NF

Prises éject. universelles

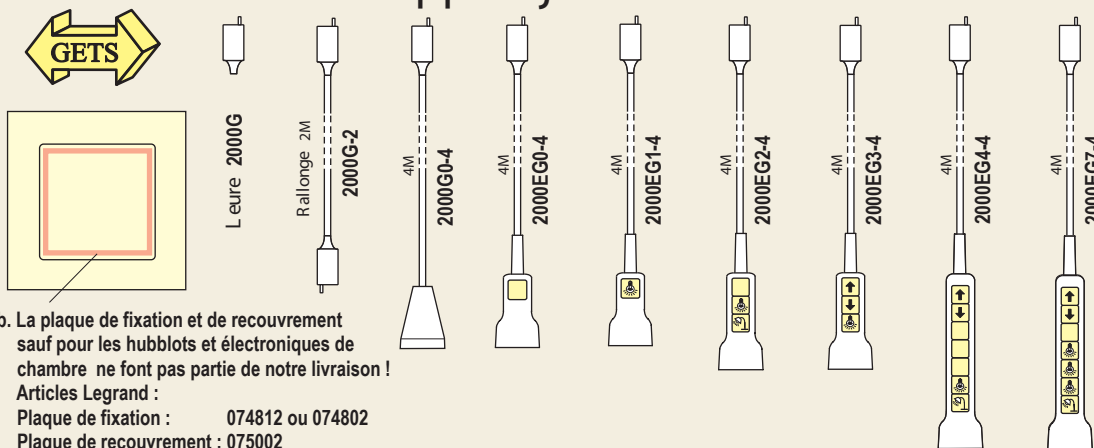

Nb. La plaque de fixation et de recouvrement
sauf pour les hublots et électroniques de
chambre ne font pas partie de notre livraison !
Articles Legrand :
Plaque de fixation : 074812 ou 074802
Plaque de recouvrement : 075002

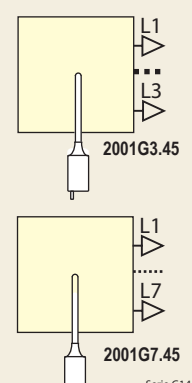

APPEL INFIRMIERE GETS, INTEGRABLE DANS LE FORMAT 45

Tirette, poussoirs et prises éjectables, pour série L, M ou P

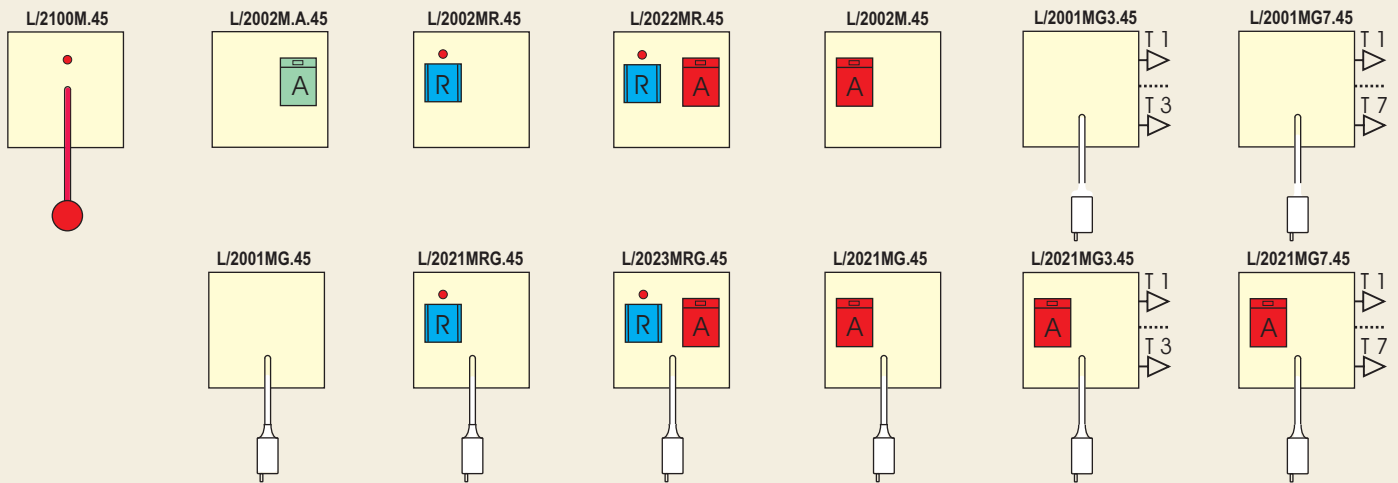

Bloc portes acquit/présence, pour hublot L ou M

Hublot plexy (passif)

L/2202P.RG.45

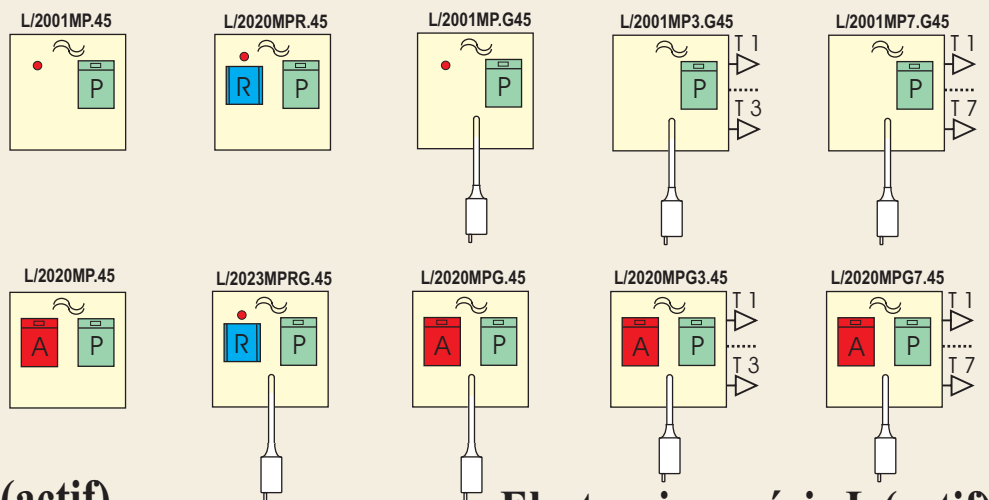
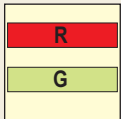

Hublot plexy série L (actif)

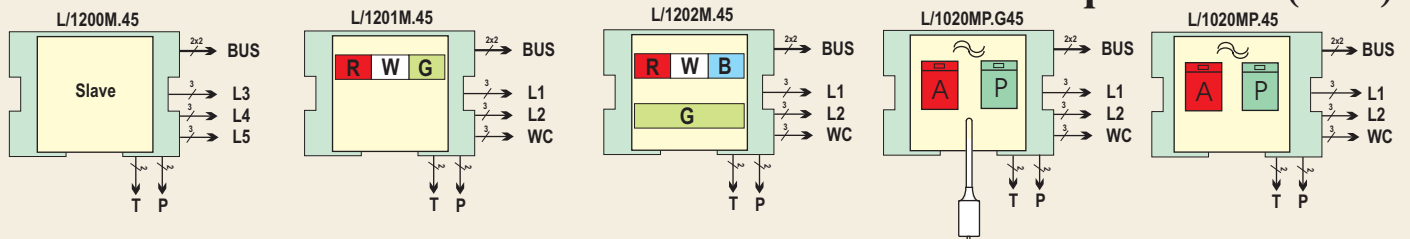

Electronique série L (actif)

Poires d'appel éjectables à ouverture. NF

Prises éject. universelles

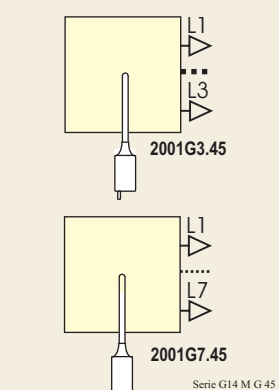
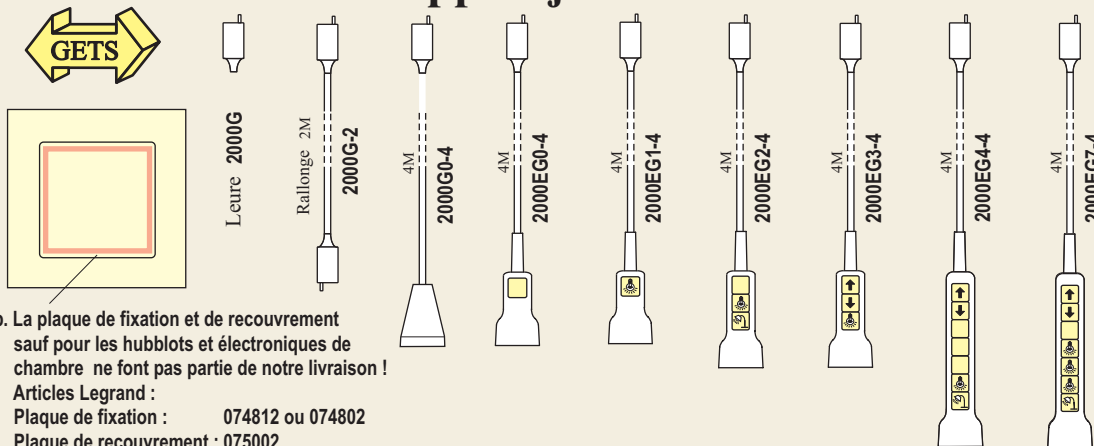

Nb. La plaque de fixation et de recouvrement sauf pour les hublots et électroniques de chambre ne font pas partie de notre livraison !
Articles Legrand :
Plaque de fixation : 074812 ou 074802
Plaque de recouvrement : 075002

Nos LOGOS , les plus couramment utilisés

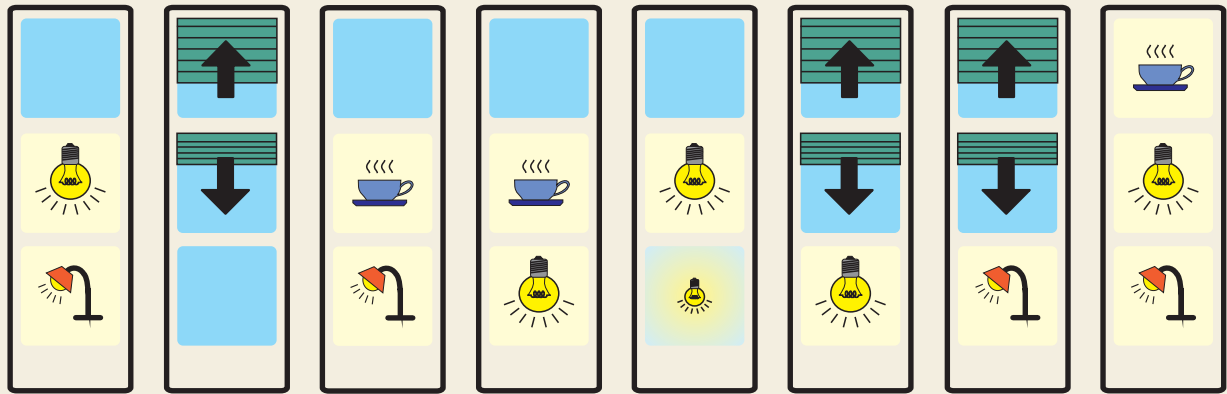

1 2 3 4 5 6 7 8

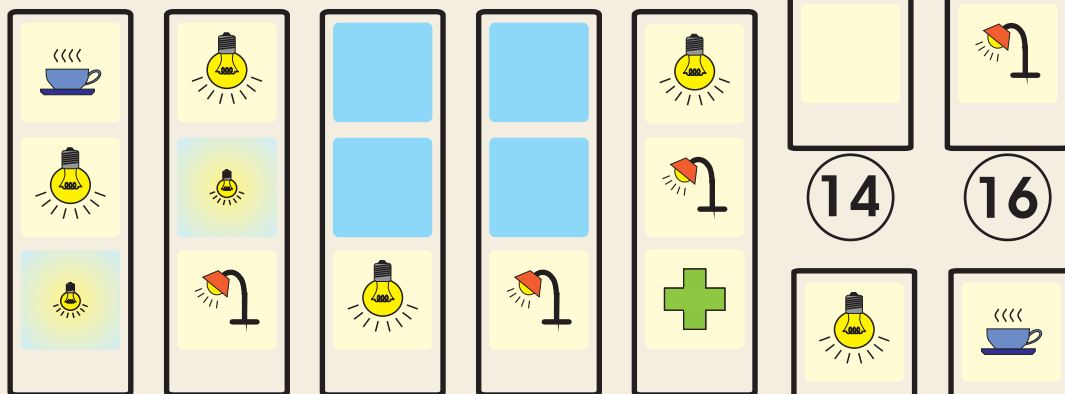

9 10 11 12 13



14 16 15 17

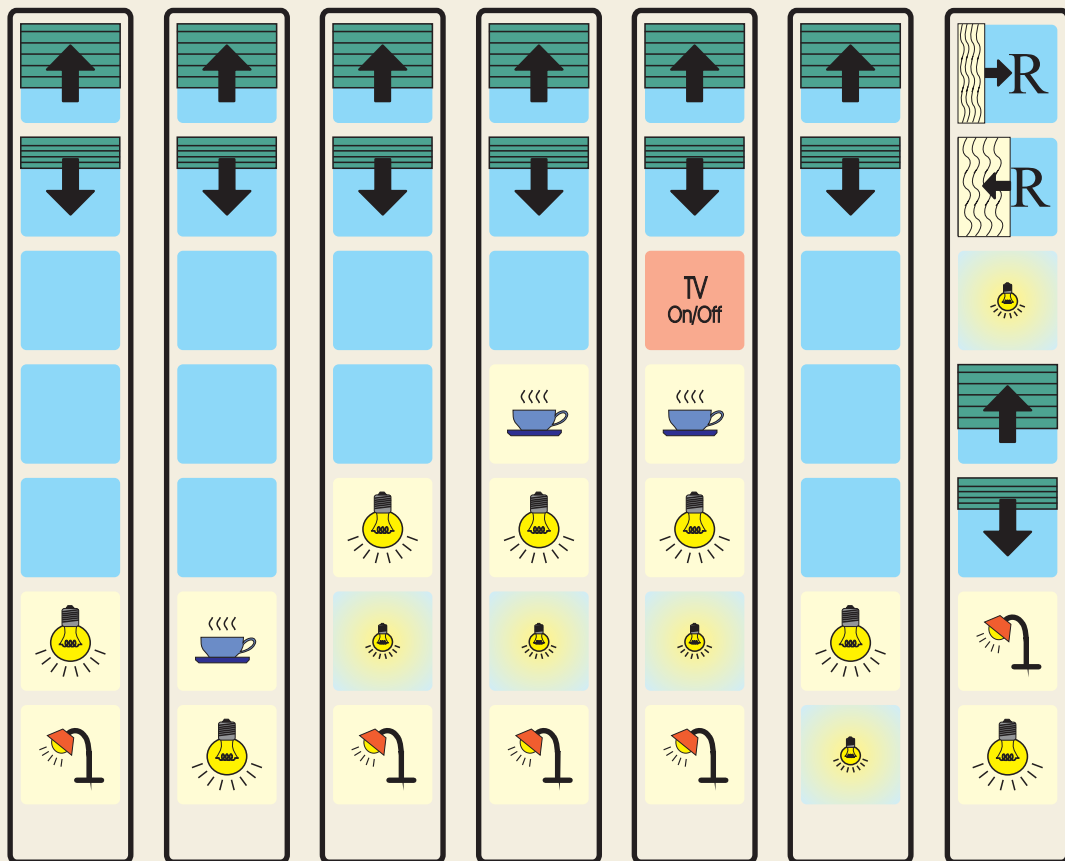

21 22 23 24 25 26 30

Exemples d'installations

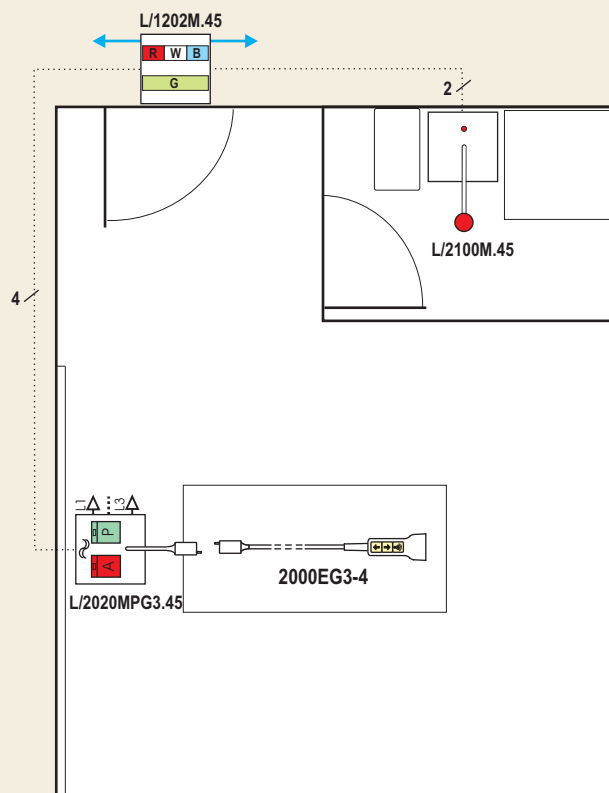
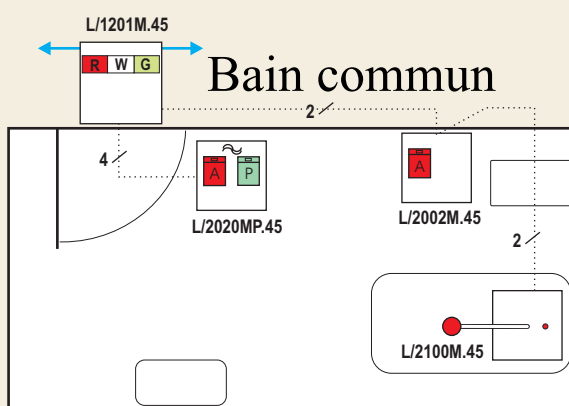
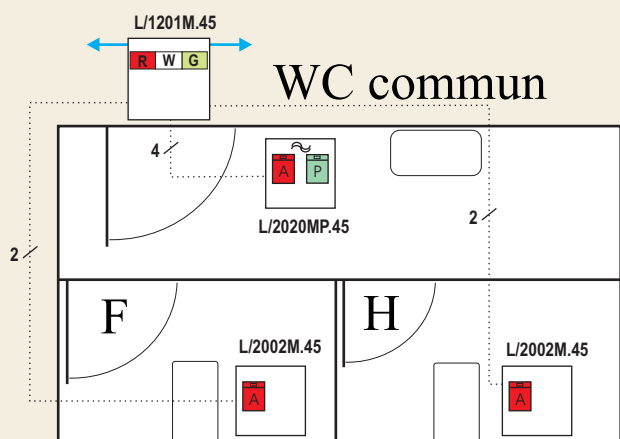

Ch. 1 lit + WC/douche

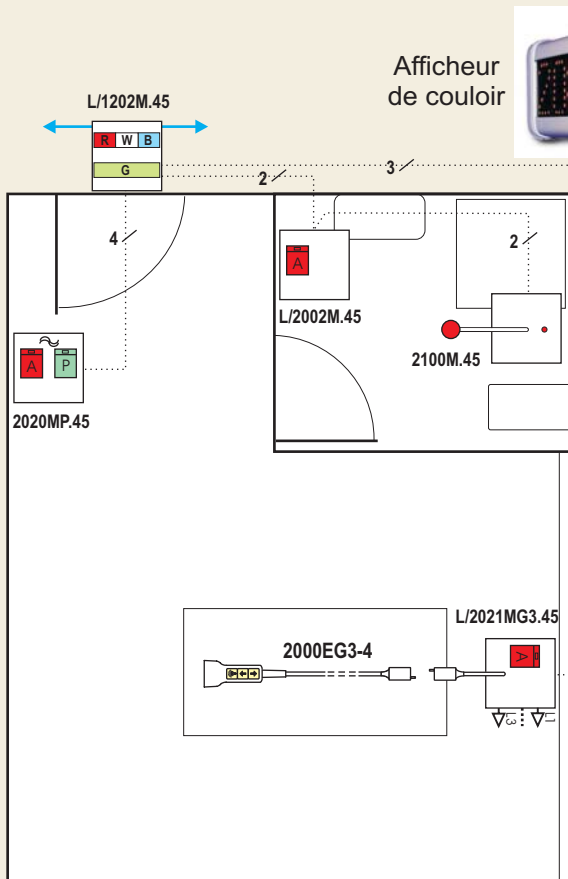

Ch. 1 lit + WC/douche/lavabo

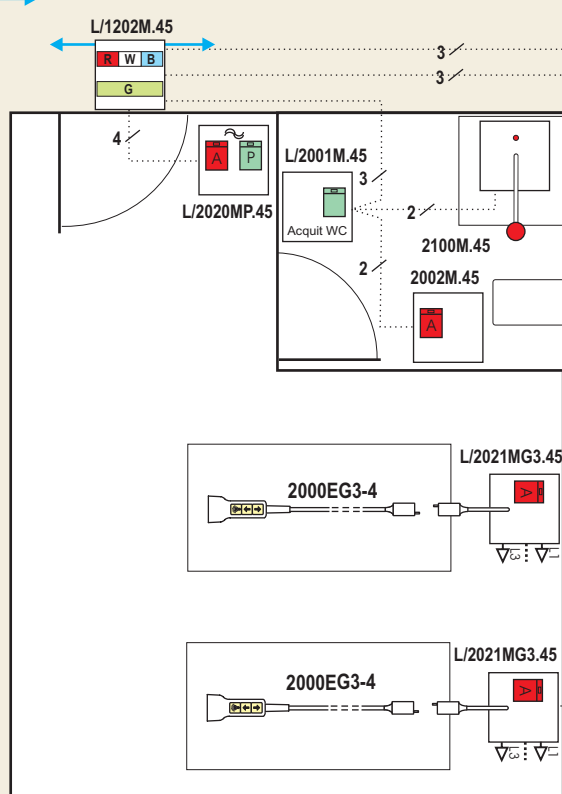

Ch. 2 lits + WC/douche

0

← BUS 2x2x0,8 →

Exemples d'installations / suite

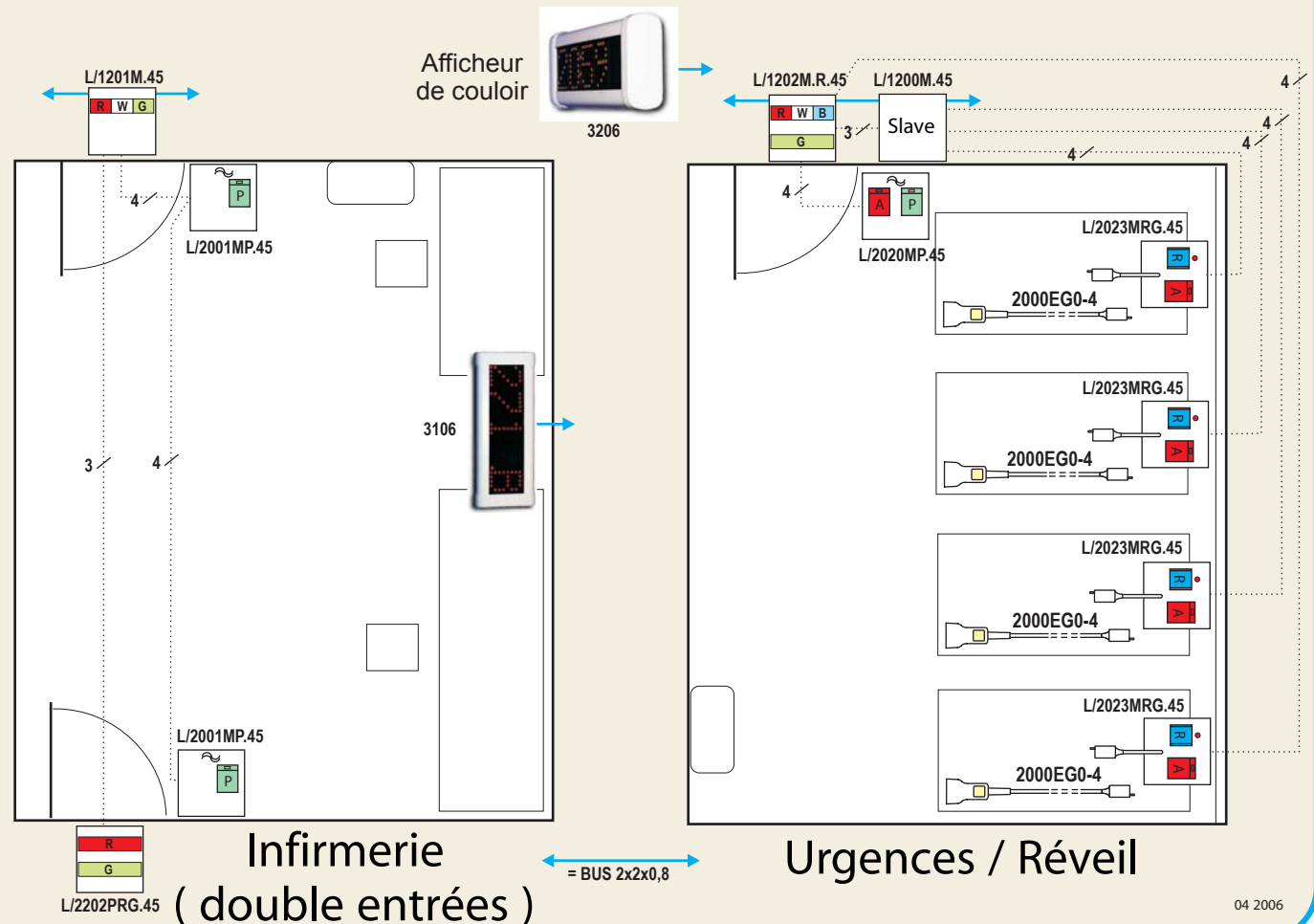
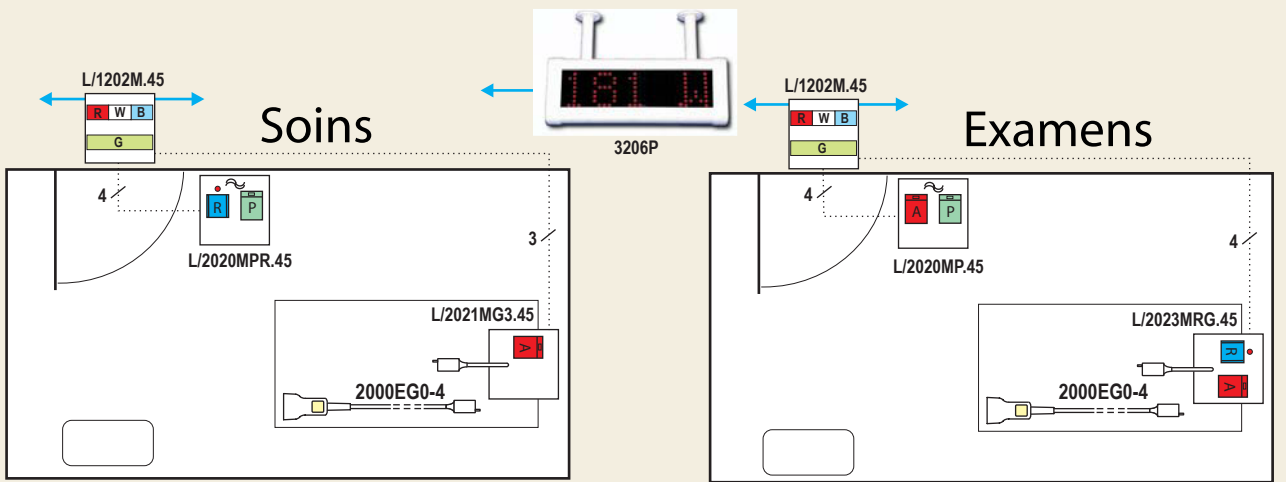
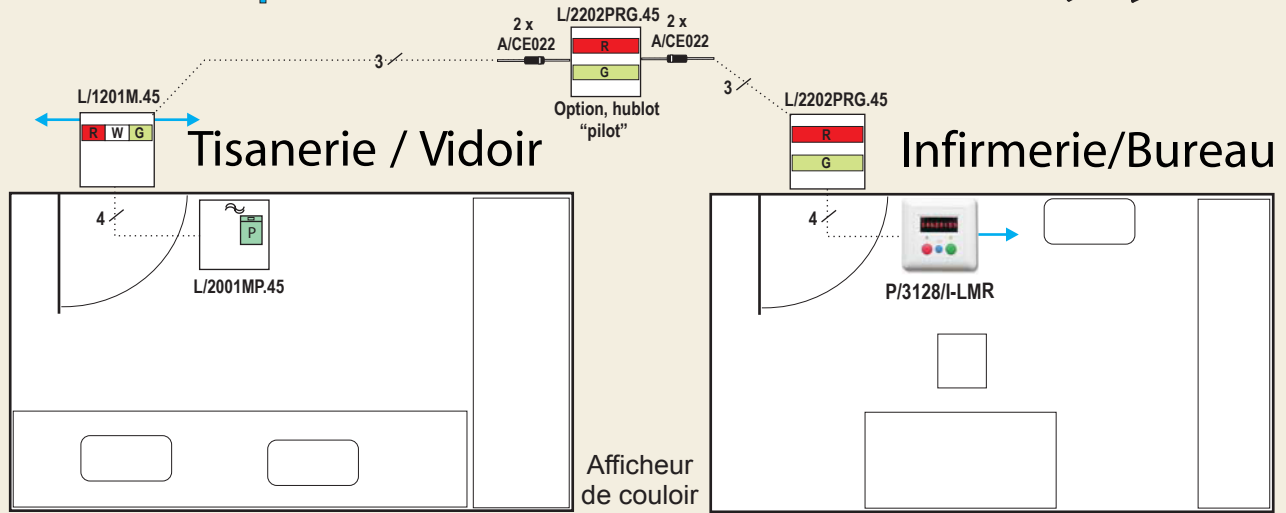

RACCORDEMENTS SERIE M.45

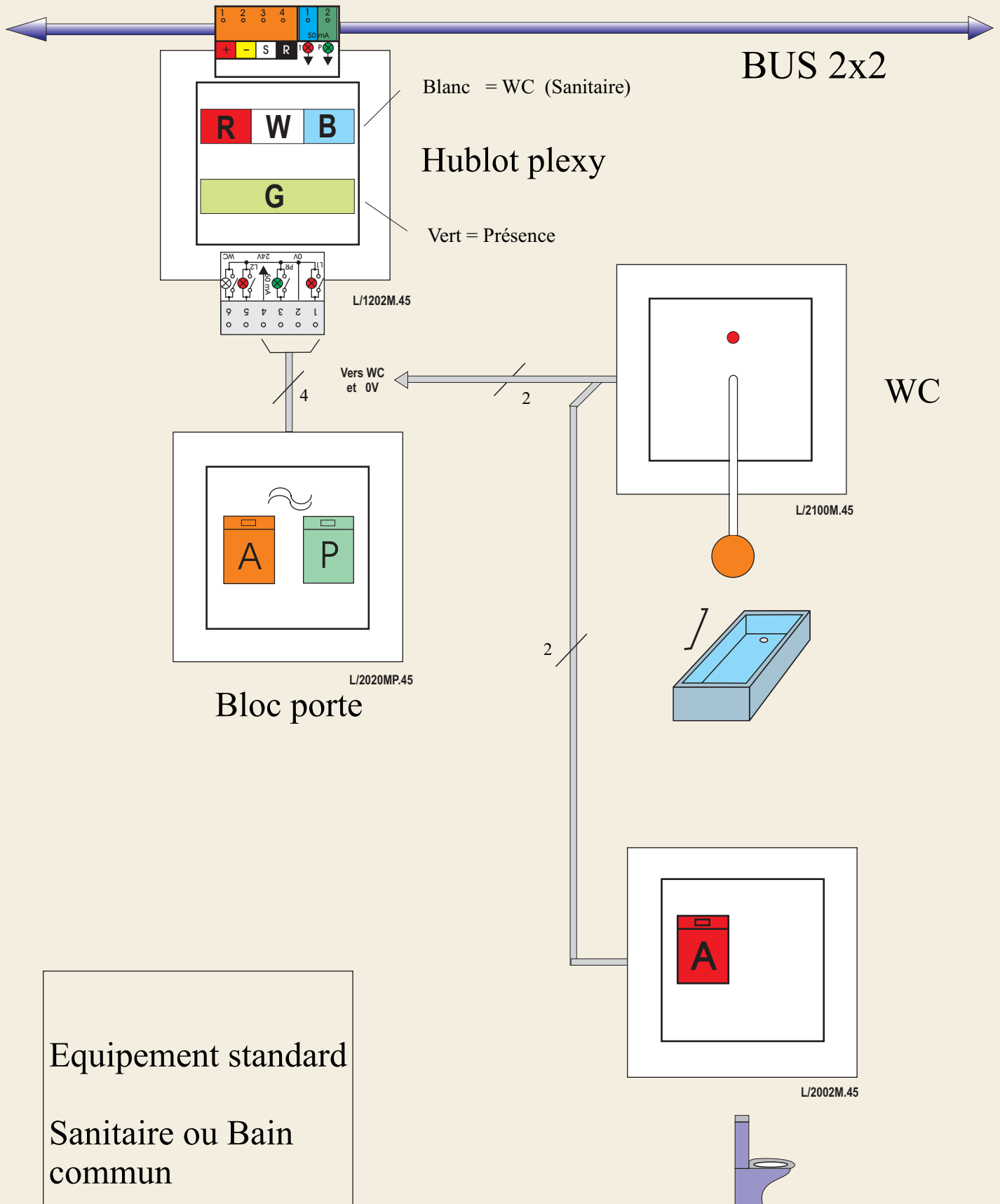

RACCORDEMENTS SERIE M.45

Electronique d'appel

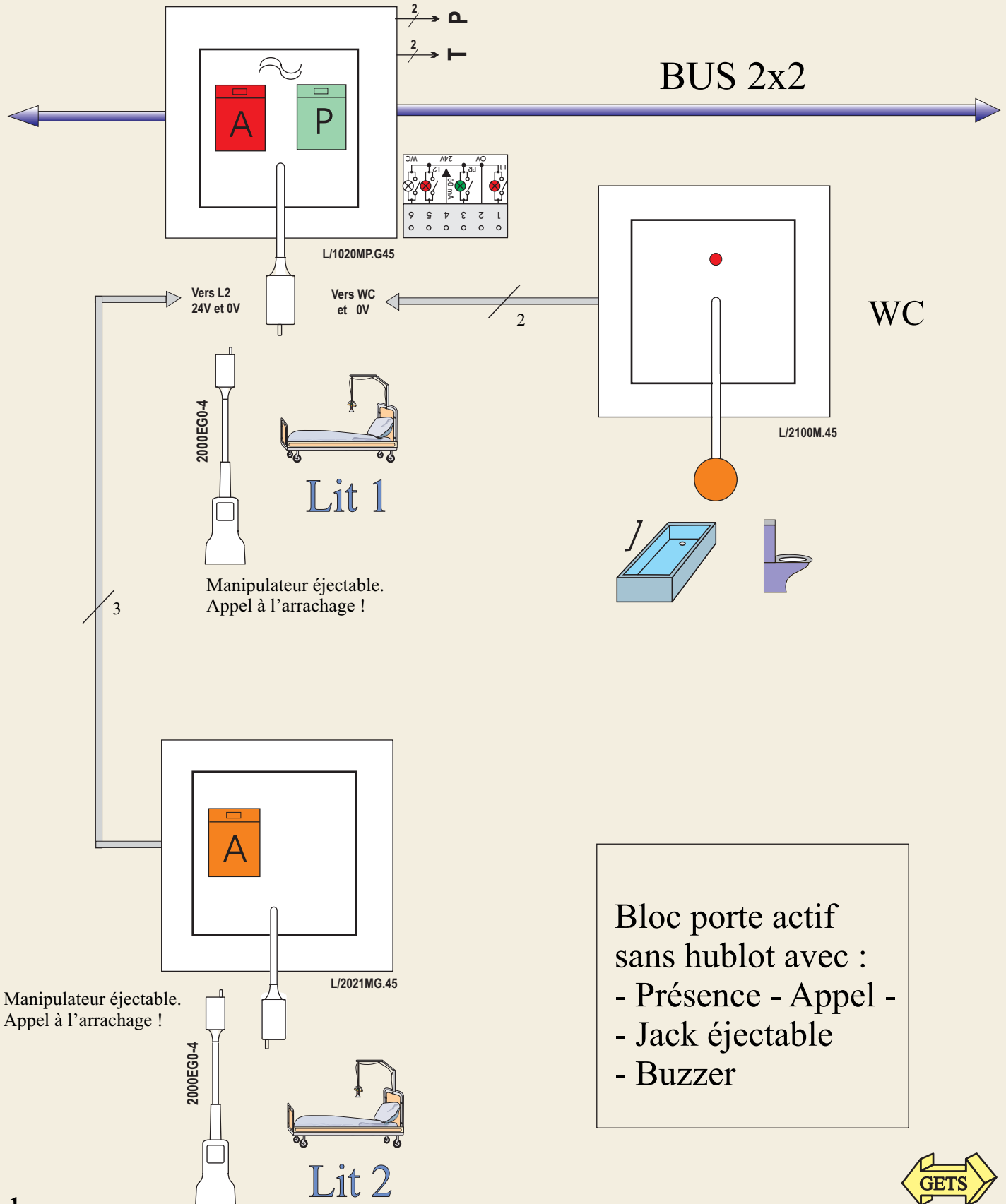

RACCORDEMENTS SERIE M.45

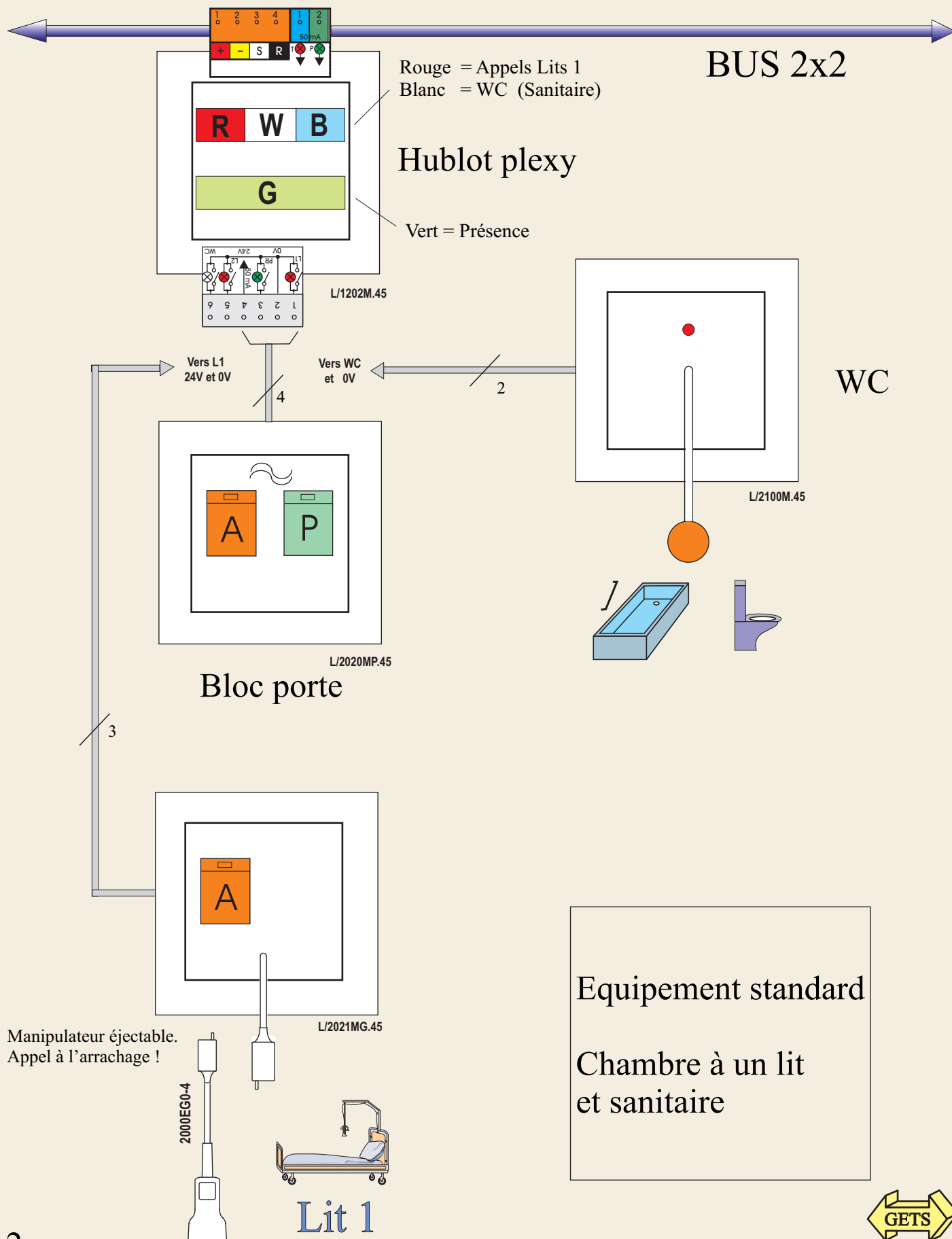

RACCORDEMENTS SERIE M.45

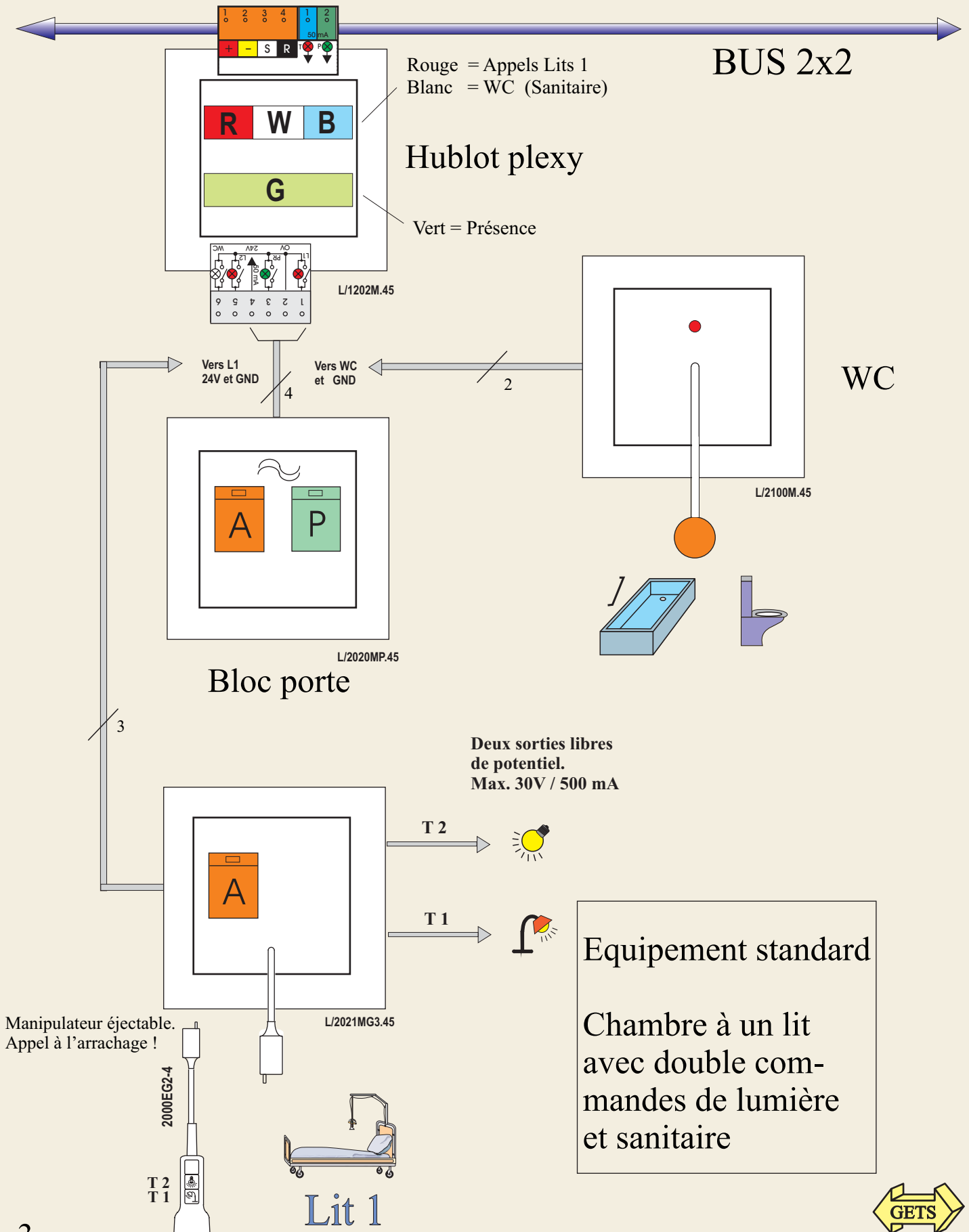

RACCORDEMENTS SERIE M.45

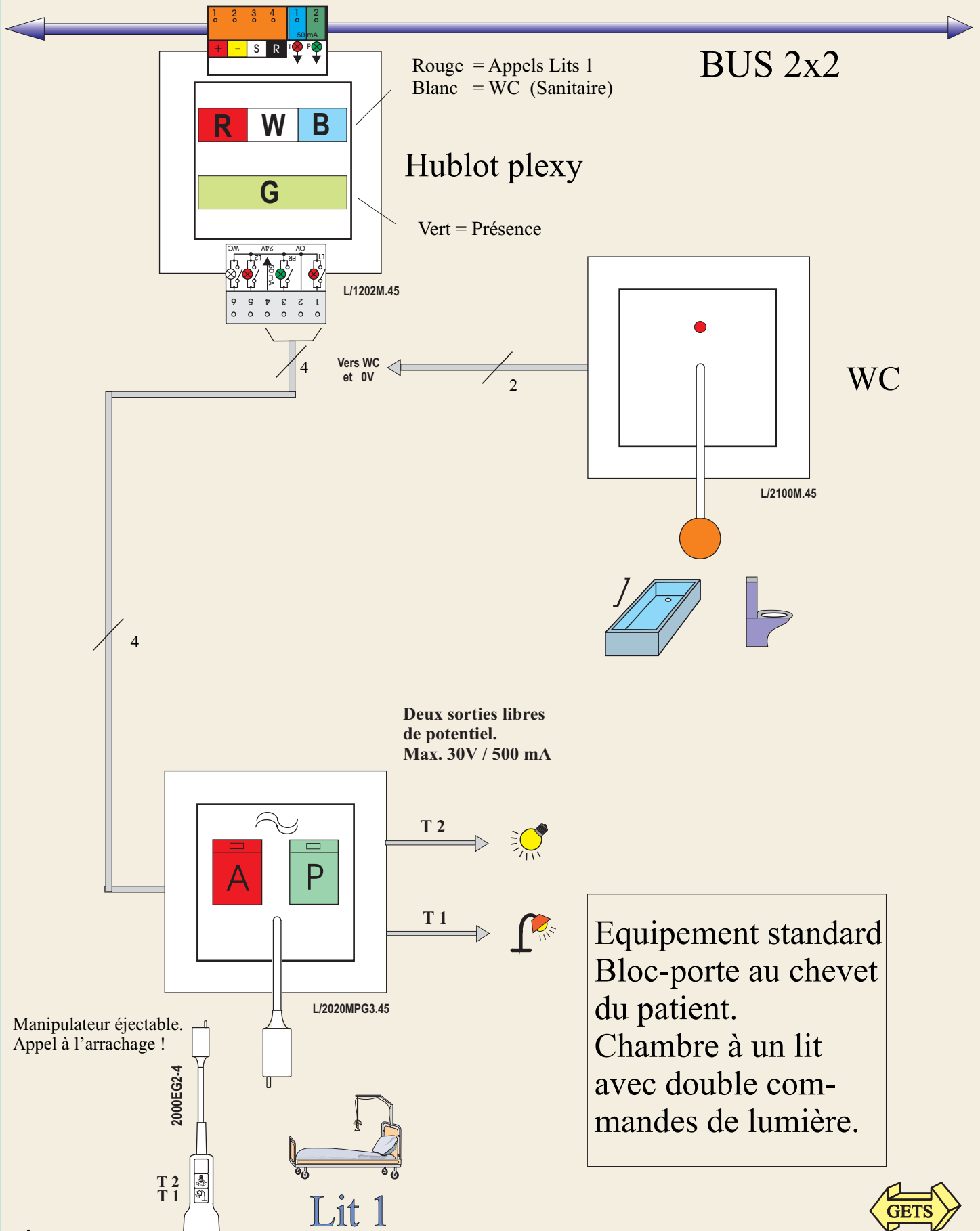

RACCORDEMENTS SERIE M.45

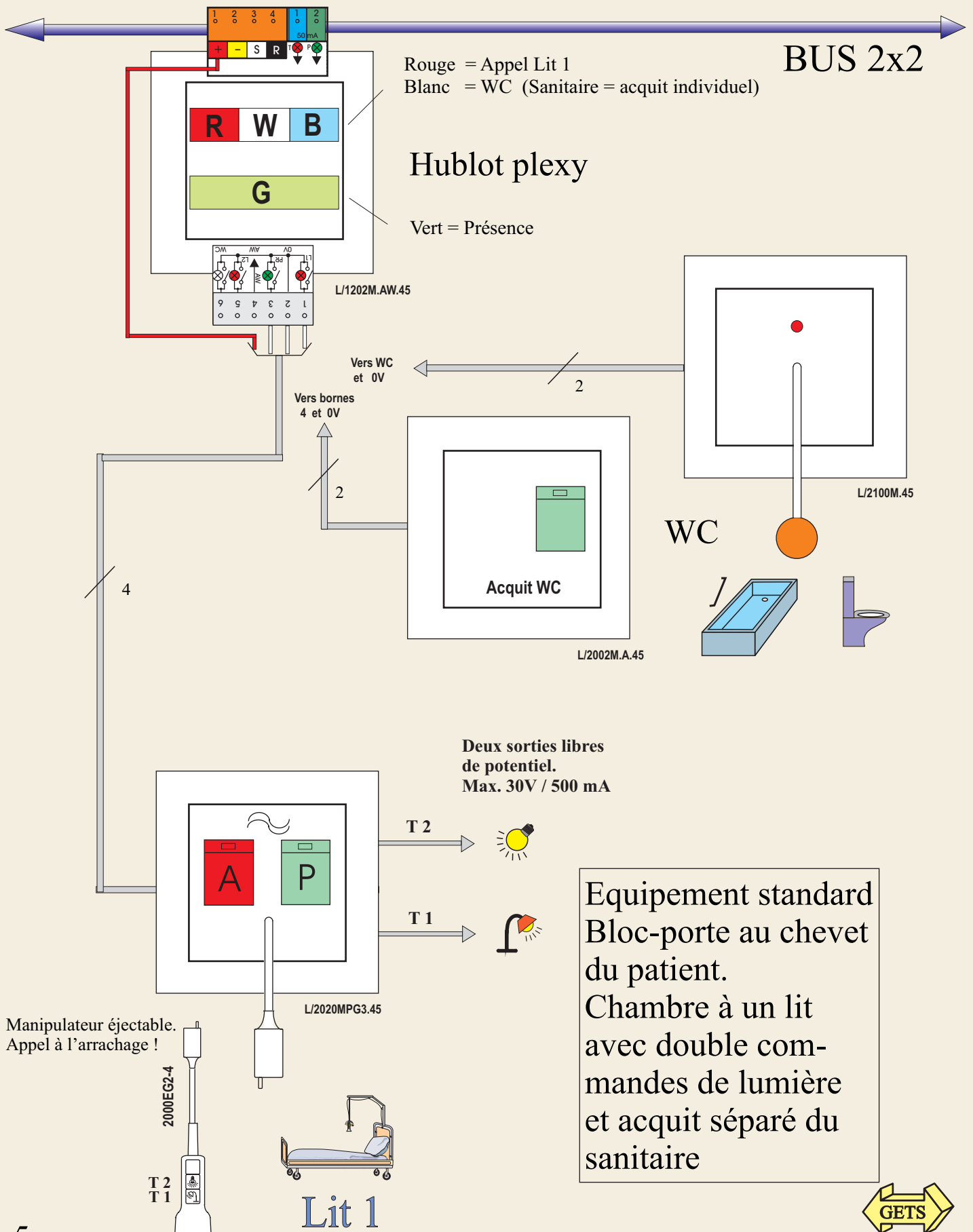

RACCORDEMENTS SERIE M.45

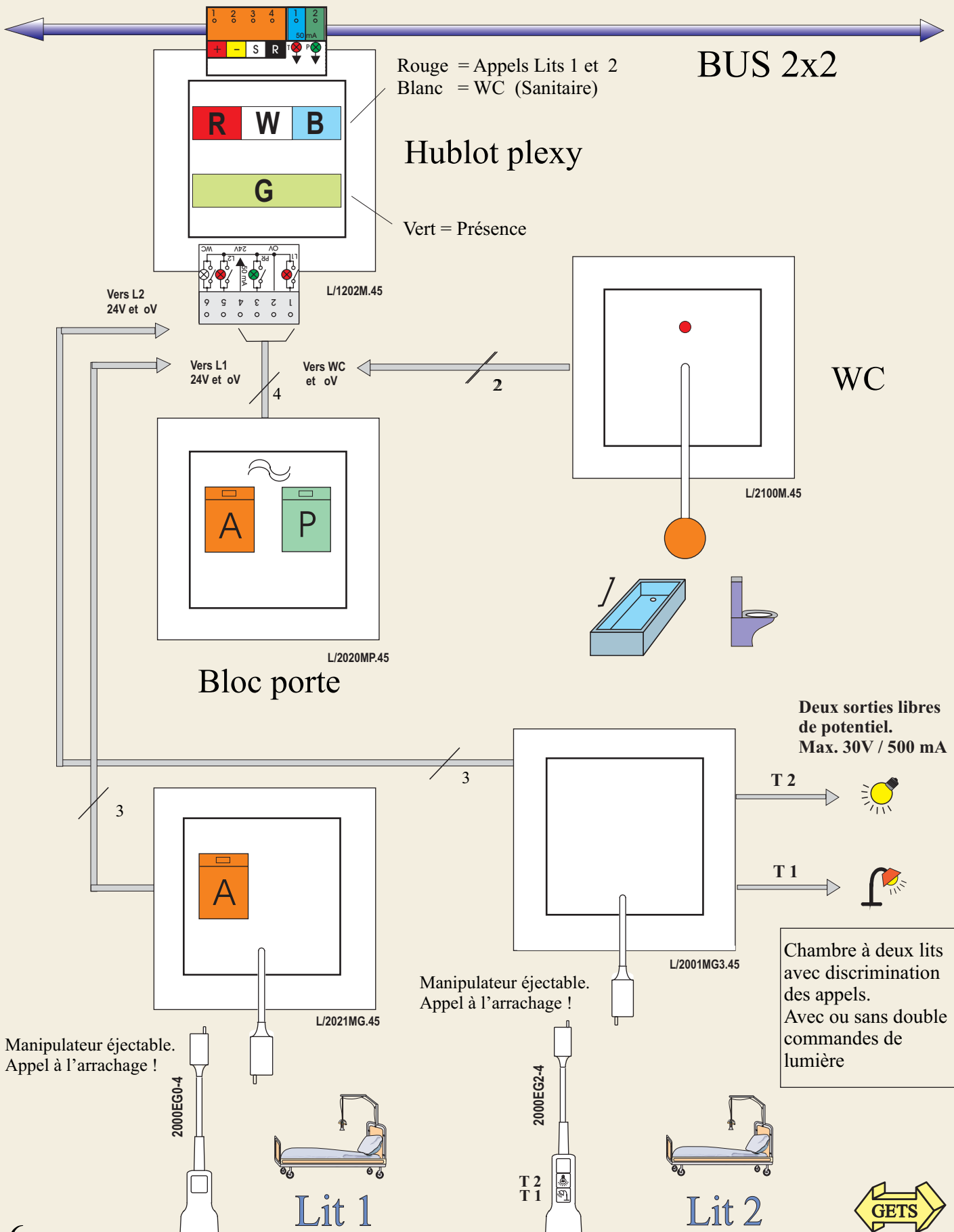

RACCORDEMENTS SERIE M.45

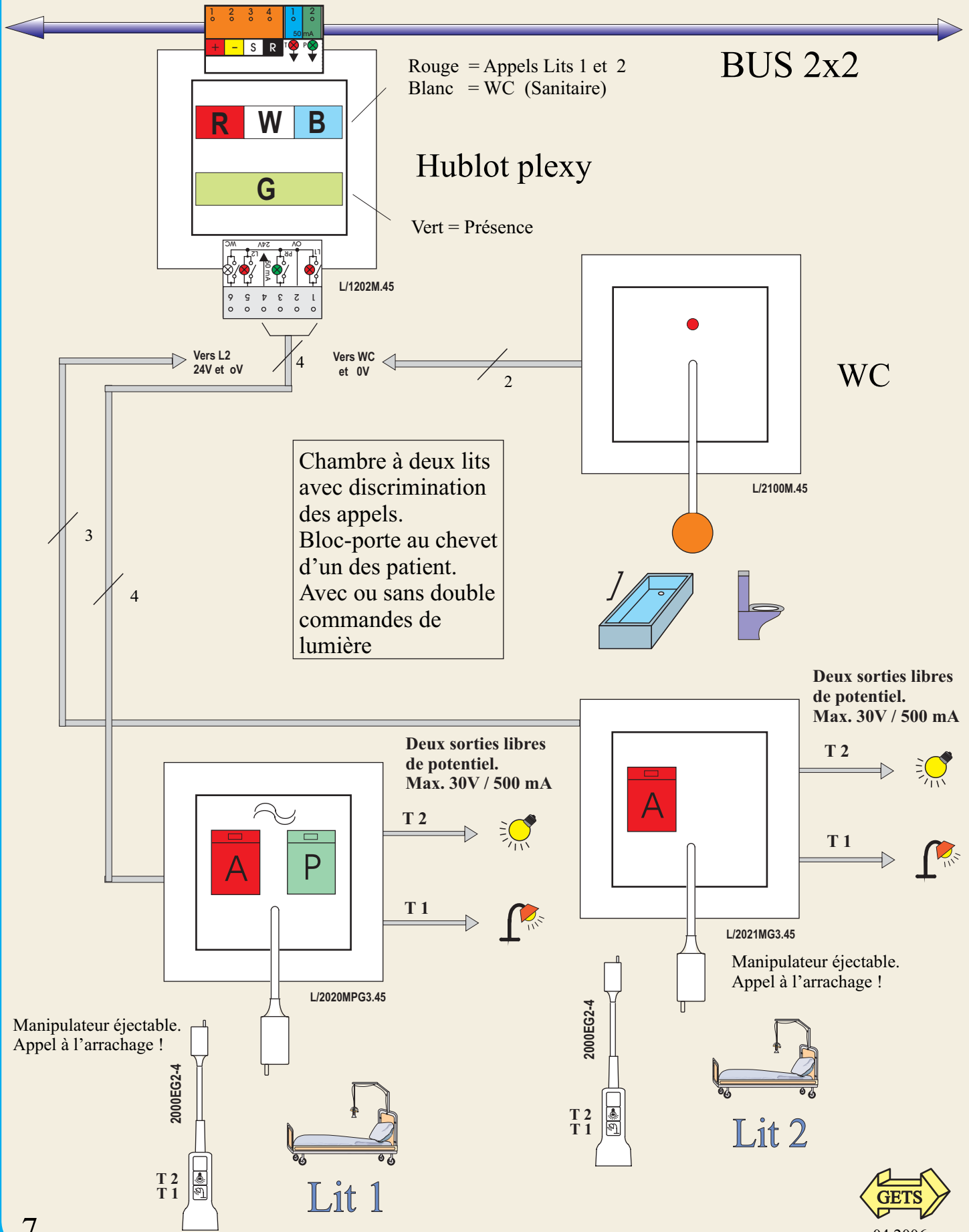

RACCORDEMENTS SERIE M.45

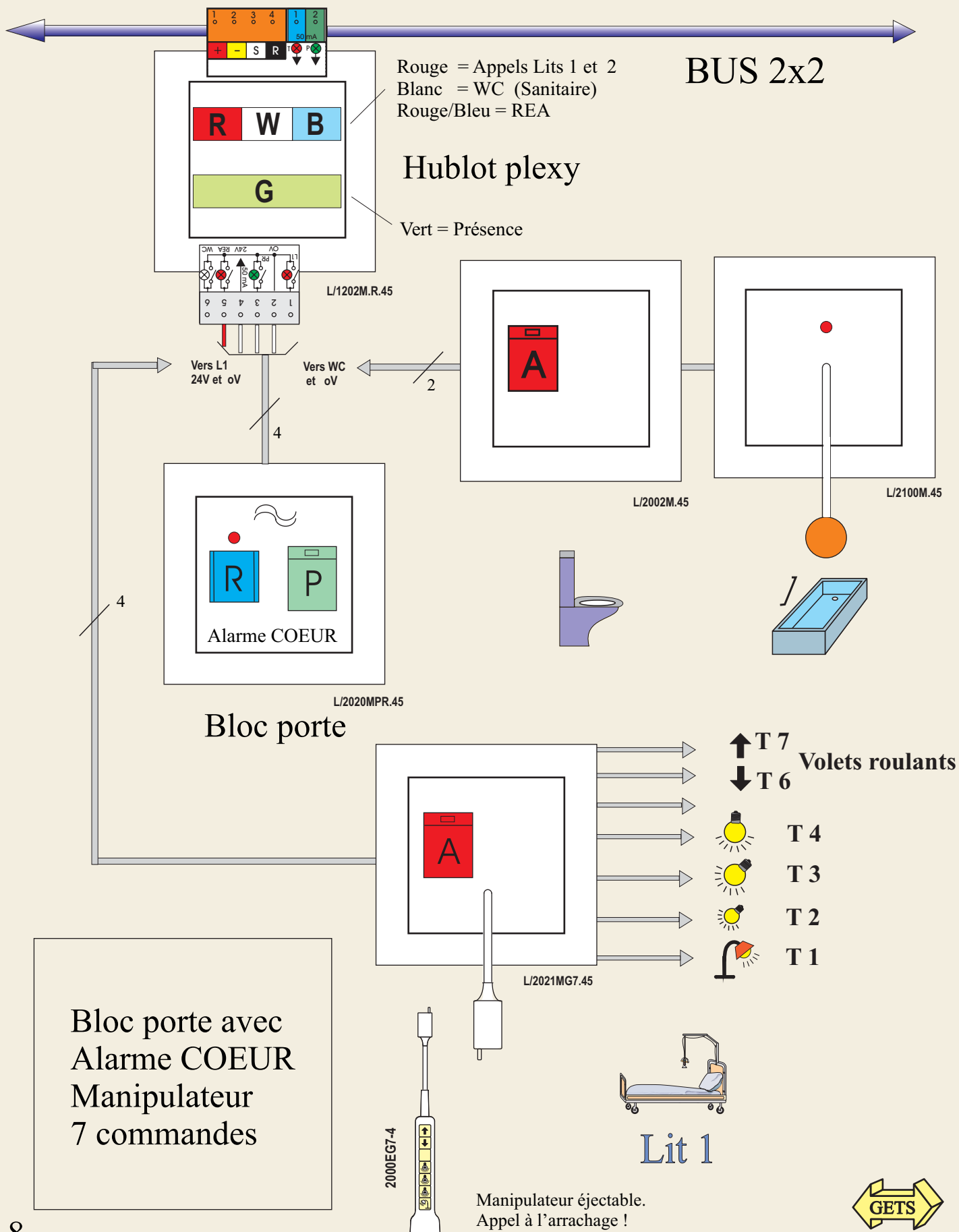

RACCORDEMENTS SERIE M.45

Compatible avec manipulateurs et tirettes autres que GETS

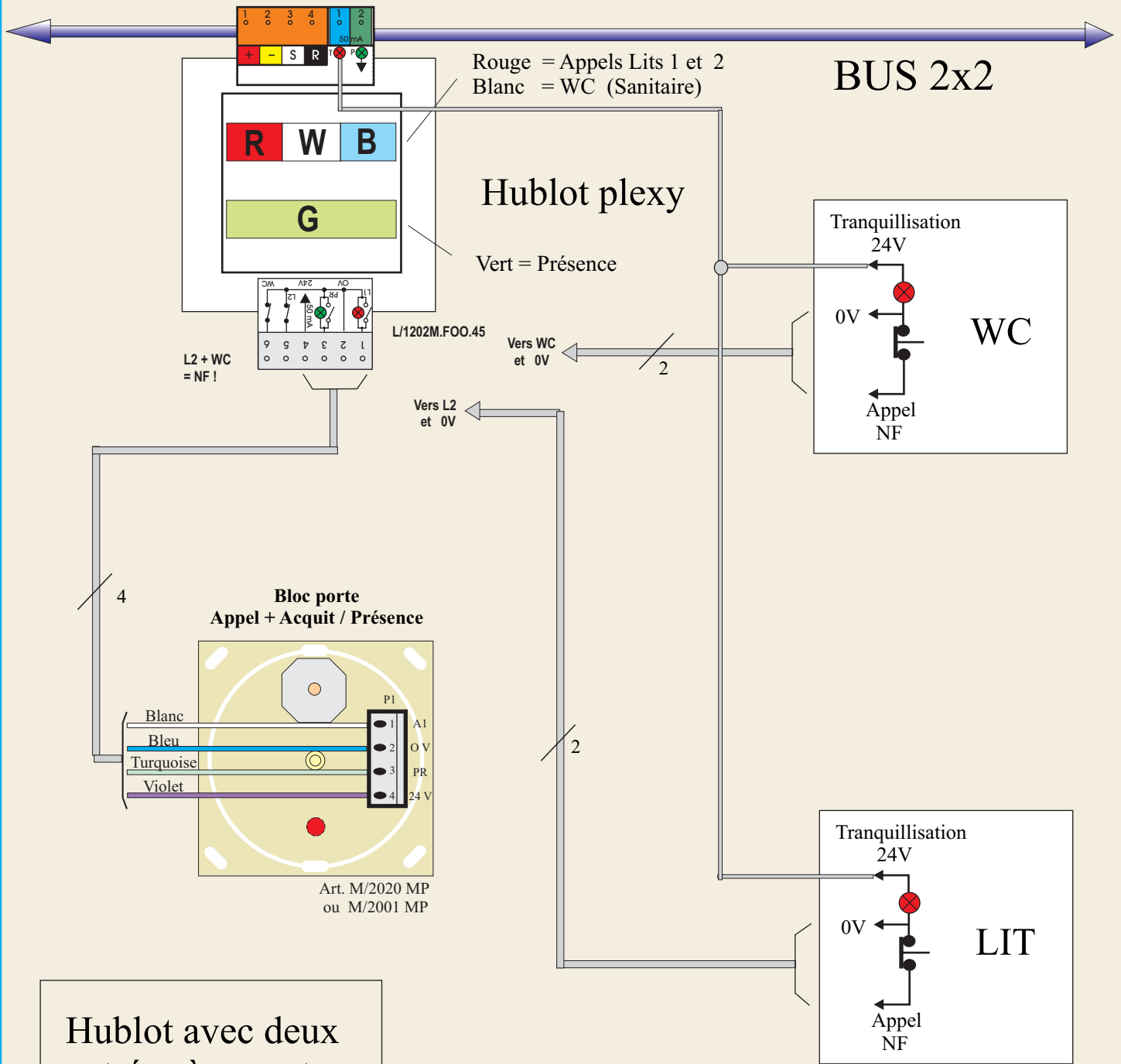

Hublot avec deux entrées à ouverture
Bloc porte série M

Manipulateur et tirette à ouverture

Lit 1



Raccordements 1500P/4 L/ MG.45

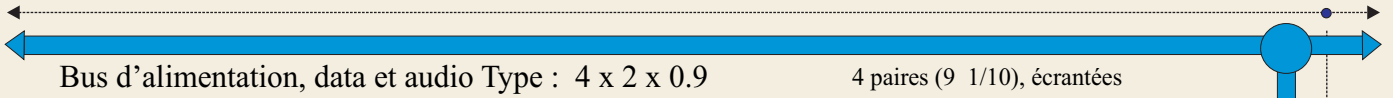

avec les manipulateurs de la série G14

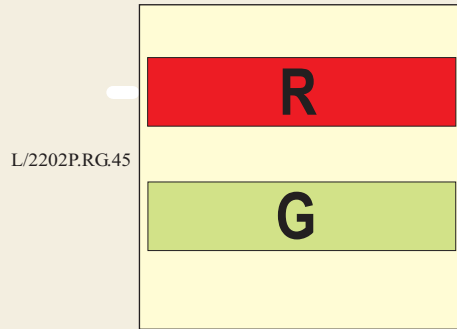

Respecter scrupuleusement nos indications de raccordements. Type de câble, couleurs etc...

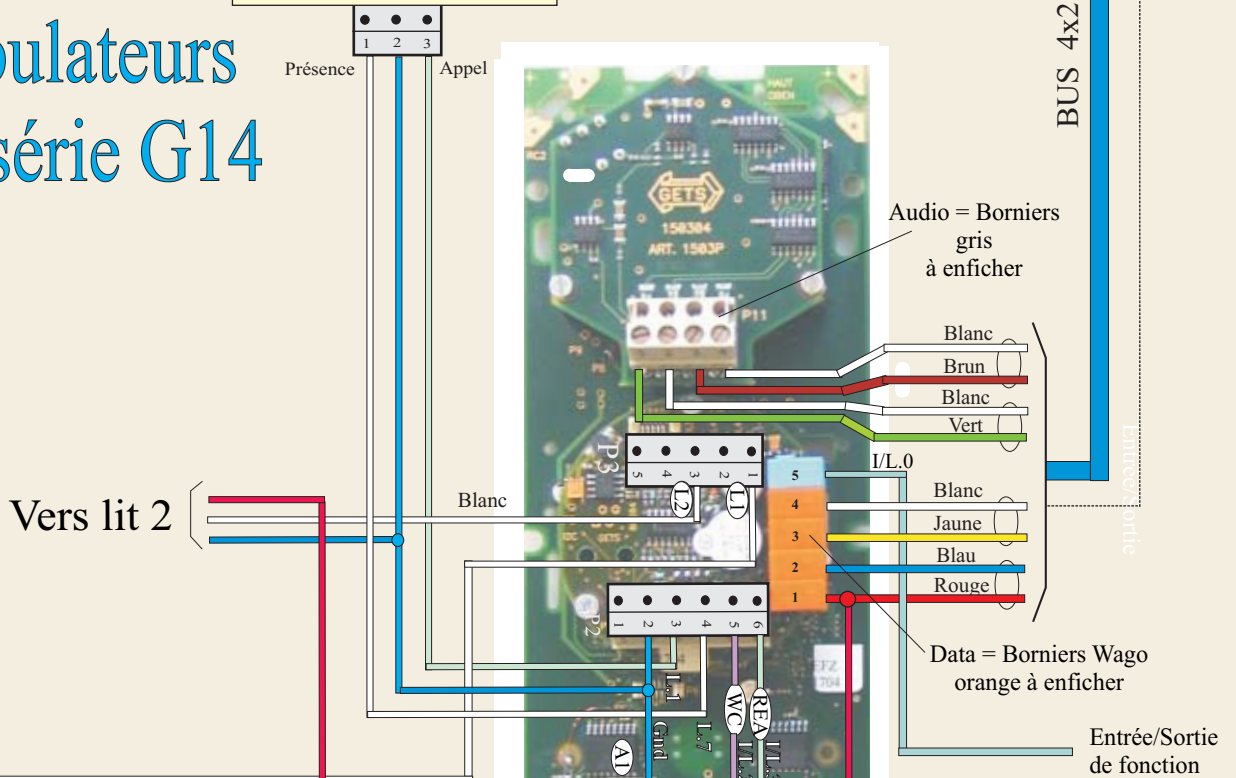

Articles 1502P/4-LMRx
1504P/4-LMRx
1508P/4-LMRx

Consommation totale avec la lampe 2202 de couloir :
Au repos : 30 mA
En présence : 60 mA
En communication : 70 mA
Avec musique ON + 40 mA

